



ALFA SRL

ZENITH SC - INSTALLATION INSTRUCTIONS

update 2.0
06/2018

GLASS DOOR WITH OVERPANEL

solutions SC2 and SSC2

Note: for installation of the glass door see instructions SC1 and SSC1

SC2.00

ZENITH SC2 - INSTALLATION INSTRUCTIONS
SINGLE GLASS DOOR WITH OVERPANEL

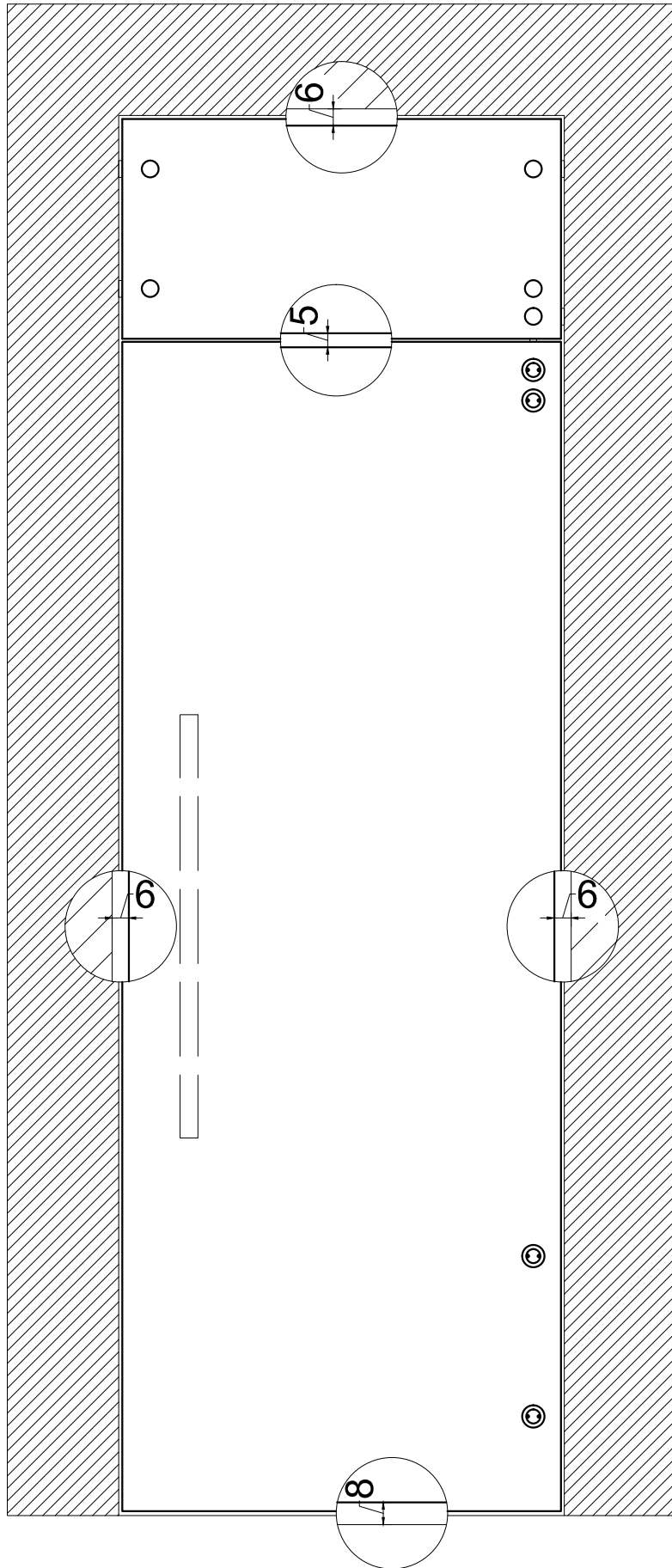

SC2.01

ZENITH SC2 - SINGLE GLASS DOOR WITH OVERPANEL

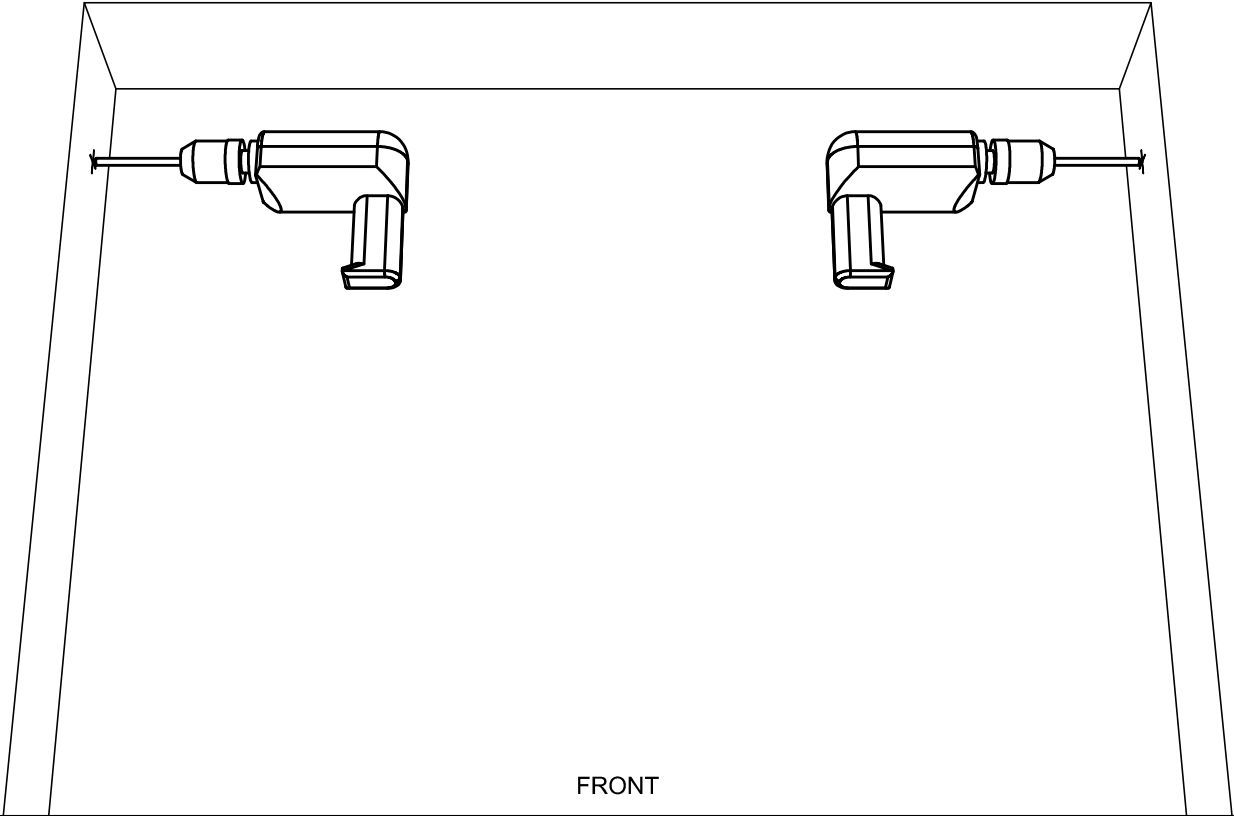

FRONT

SC2.02

ZENITH SC2 - HOLE FOR TOP WALL ACCESSORY

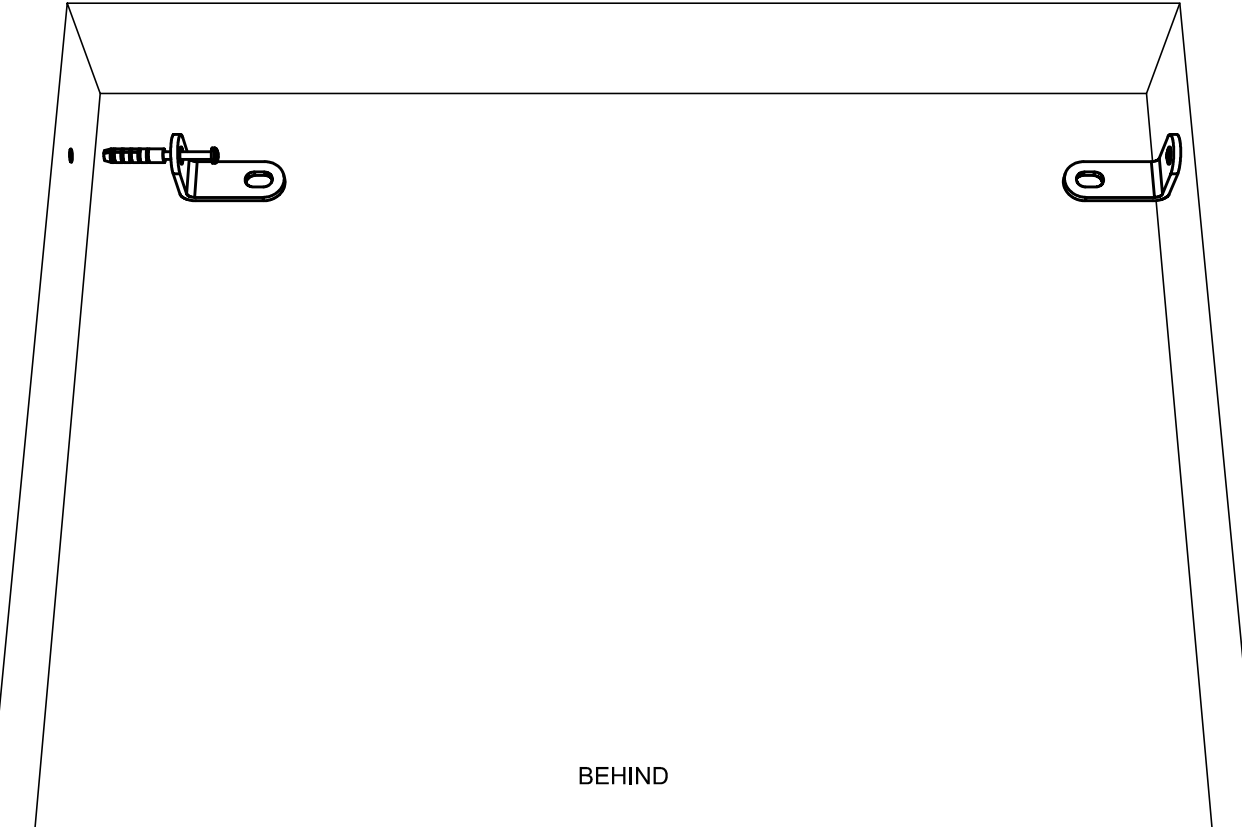
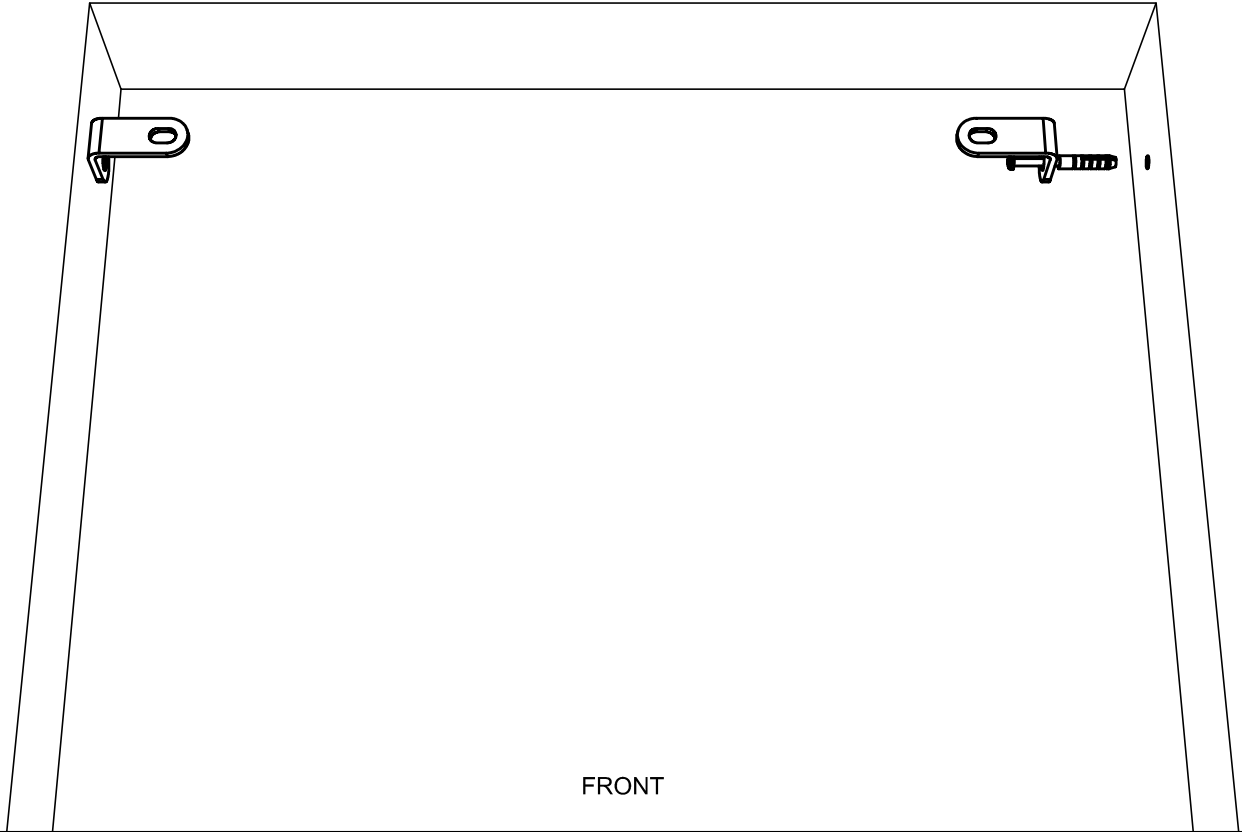

SC2.03

ZENITH SC2 - FIX THE TOP BRACKETS

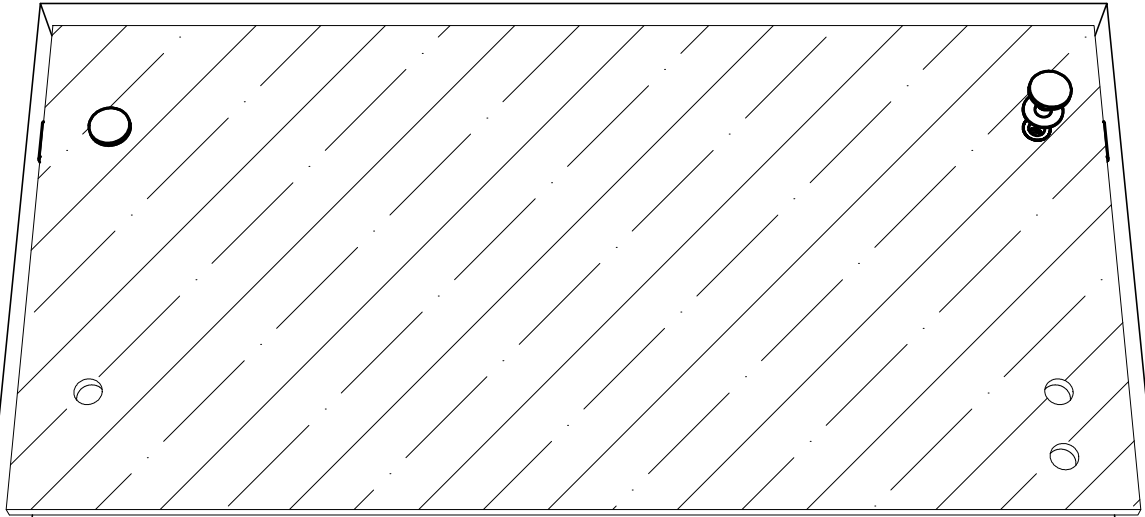

FRONT

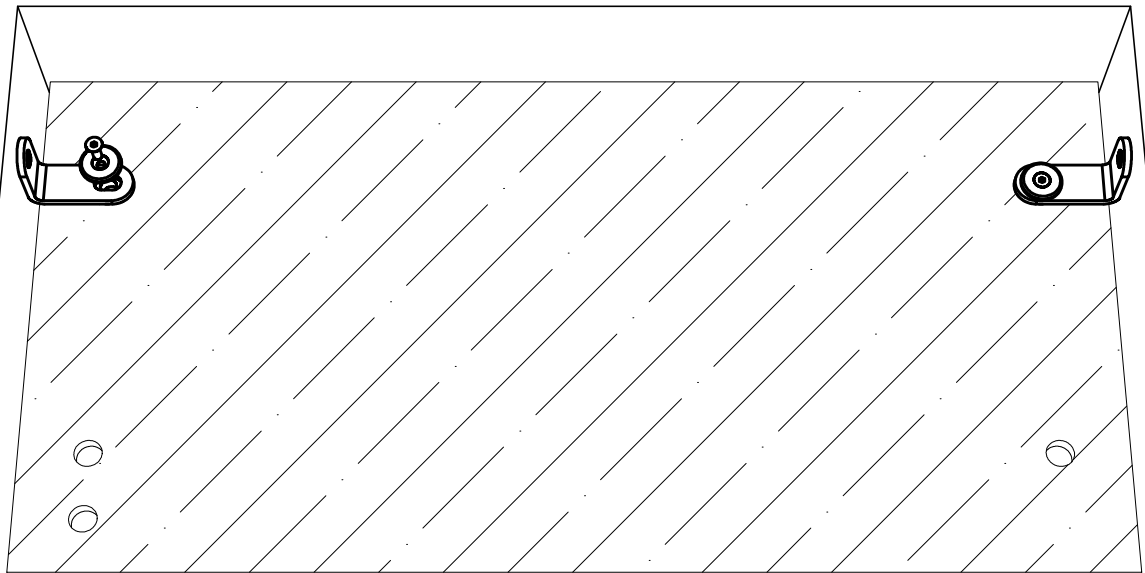

BEHIND

SC2.04

ZENITH SC2 - INSTALL THE OVERPANEL

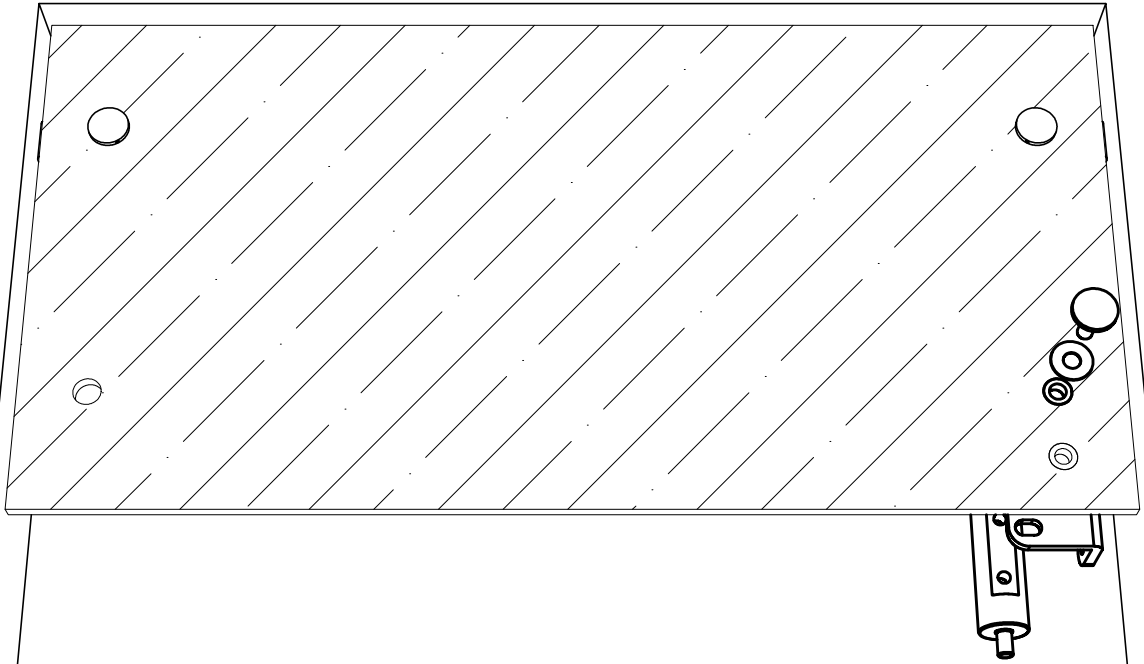

FRONT

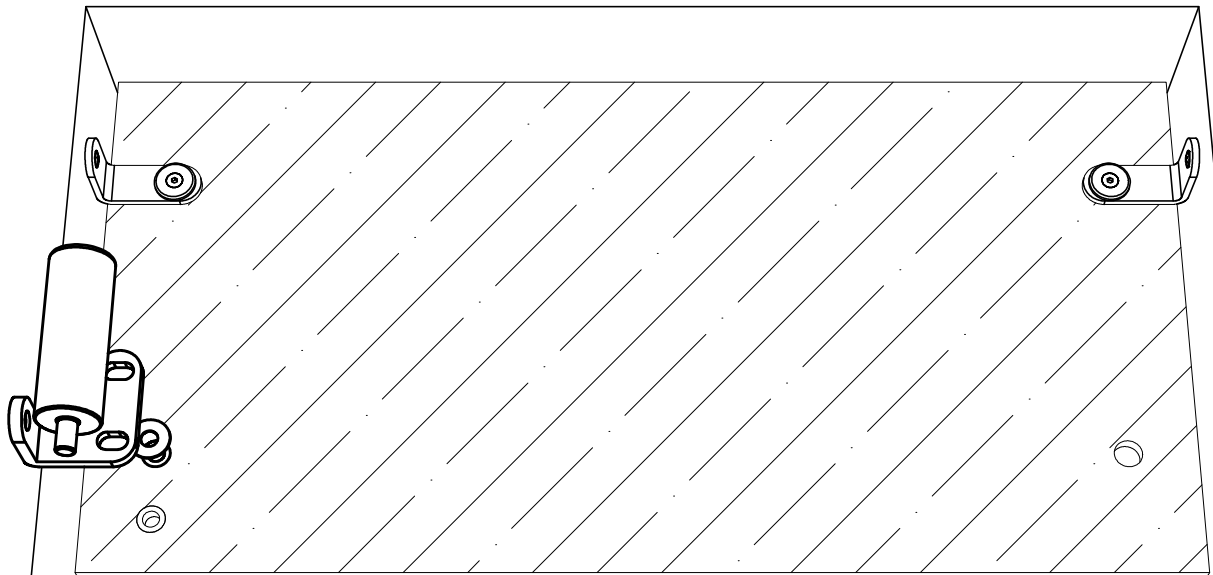

BEHIND

SC2.05

ZENITH SC2 - FIX UP THE INDICATED ACCESSORY WITH ONLY THE TOP PIVOT

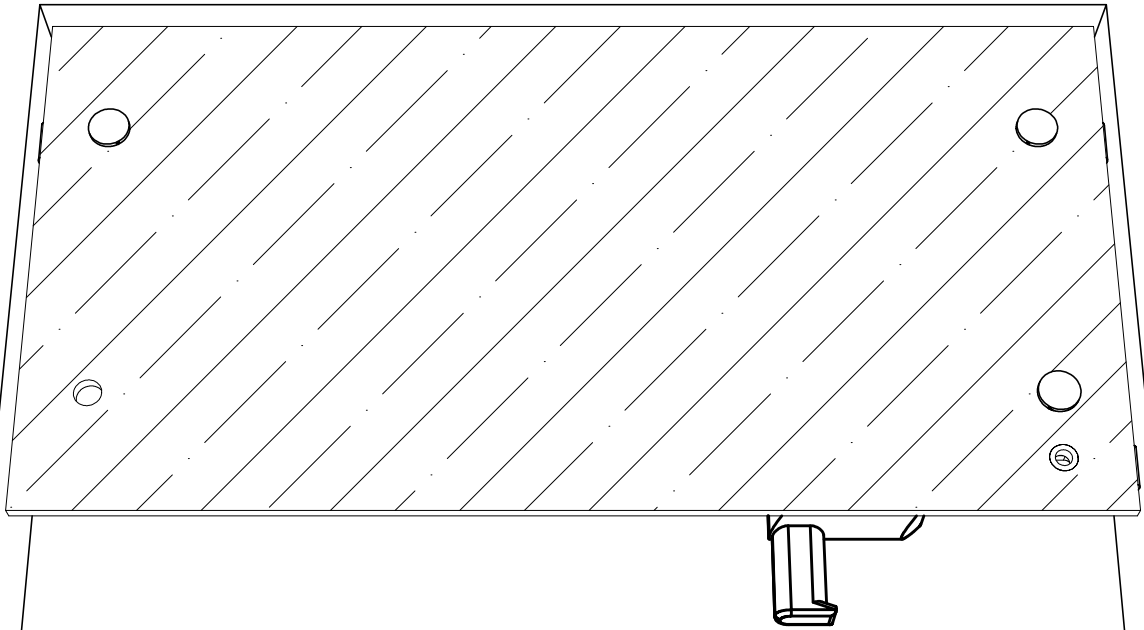

FRONT

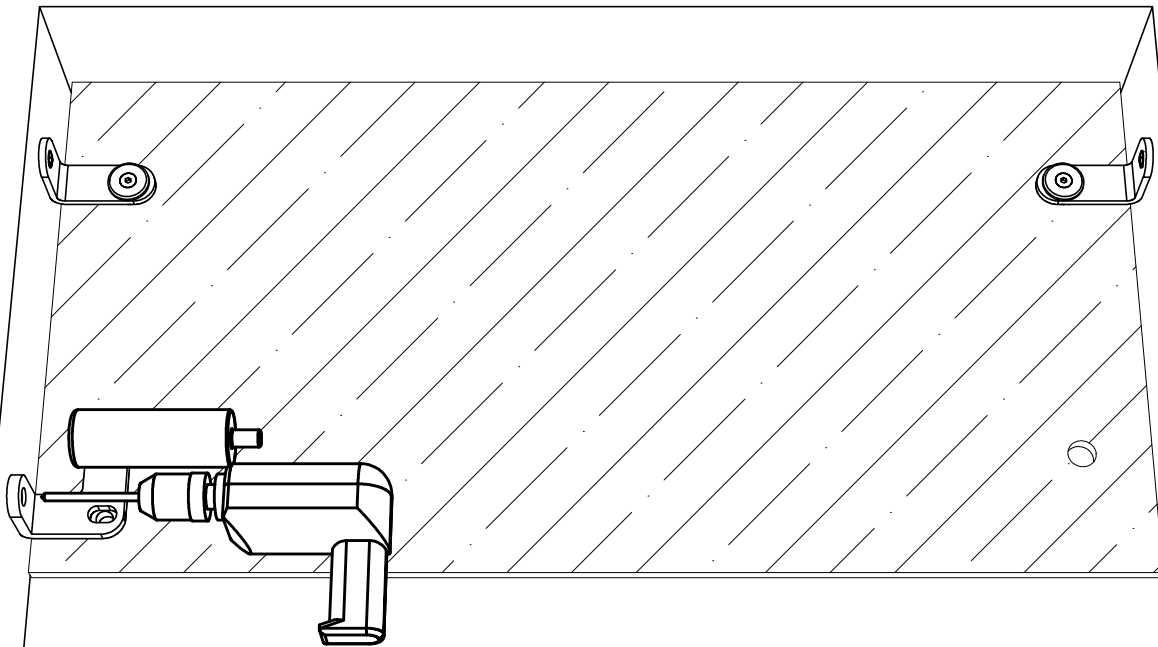

BEHIND

SC2.06

ZENITH SC2 - DRILL THE WALL AS INDICATED

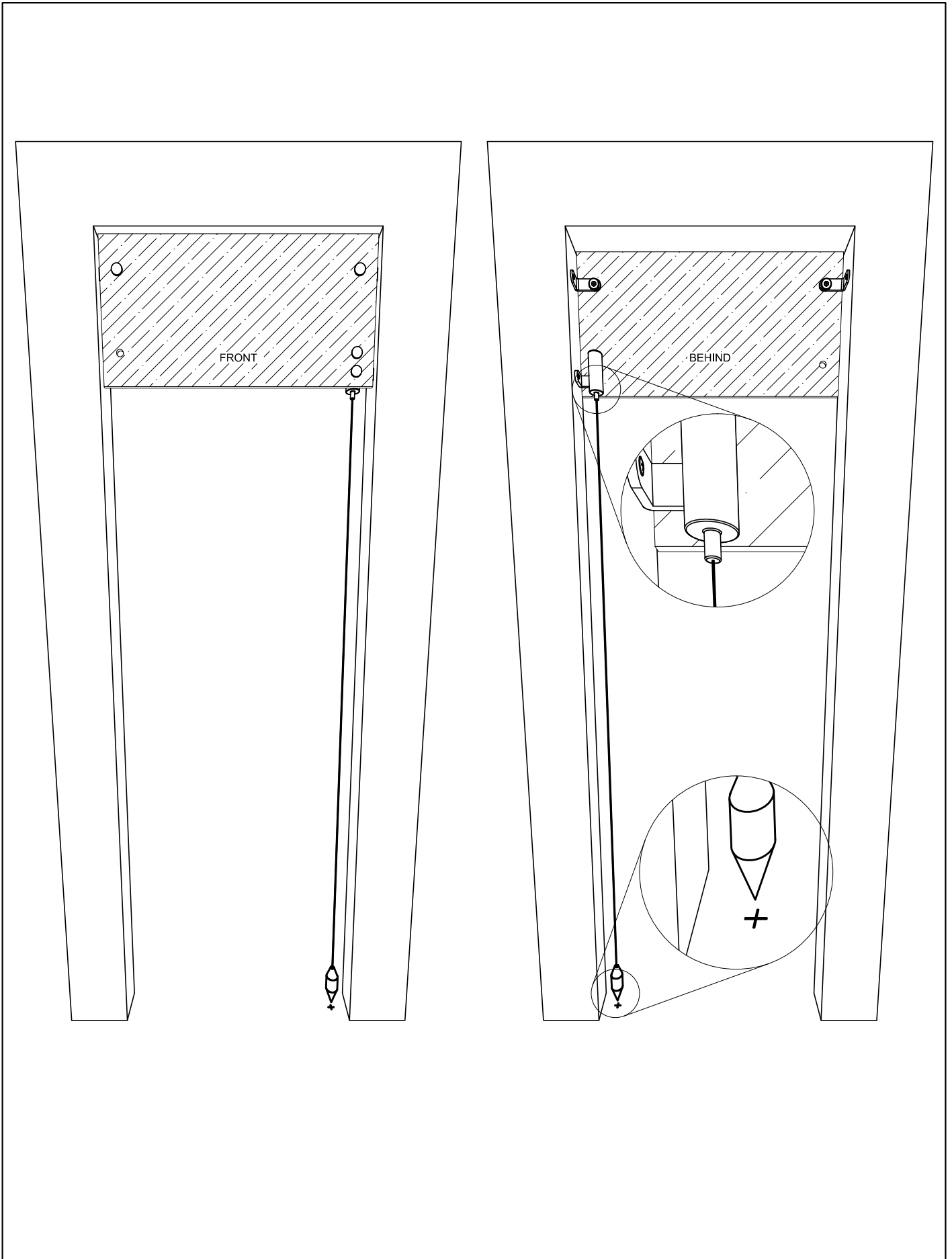

SC2.07

ZENITH SC2 - FIND THE CORRECT POSITION IN THE FLOOR AS INDICATED

FRONT



BEHIND



SC2.08

ZENITH SC2 - PERFORATE AND ANCHOR THE BOTTOM
ACCESSORY INTO THE FLOOR

FRONT

BEHIND

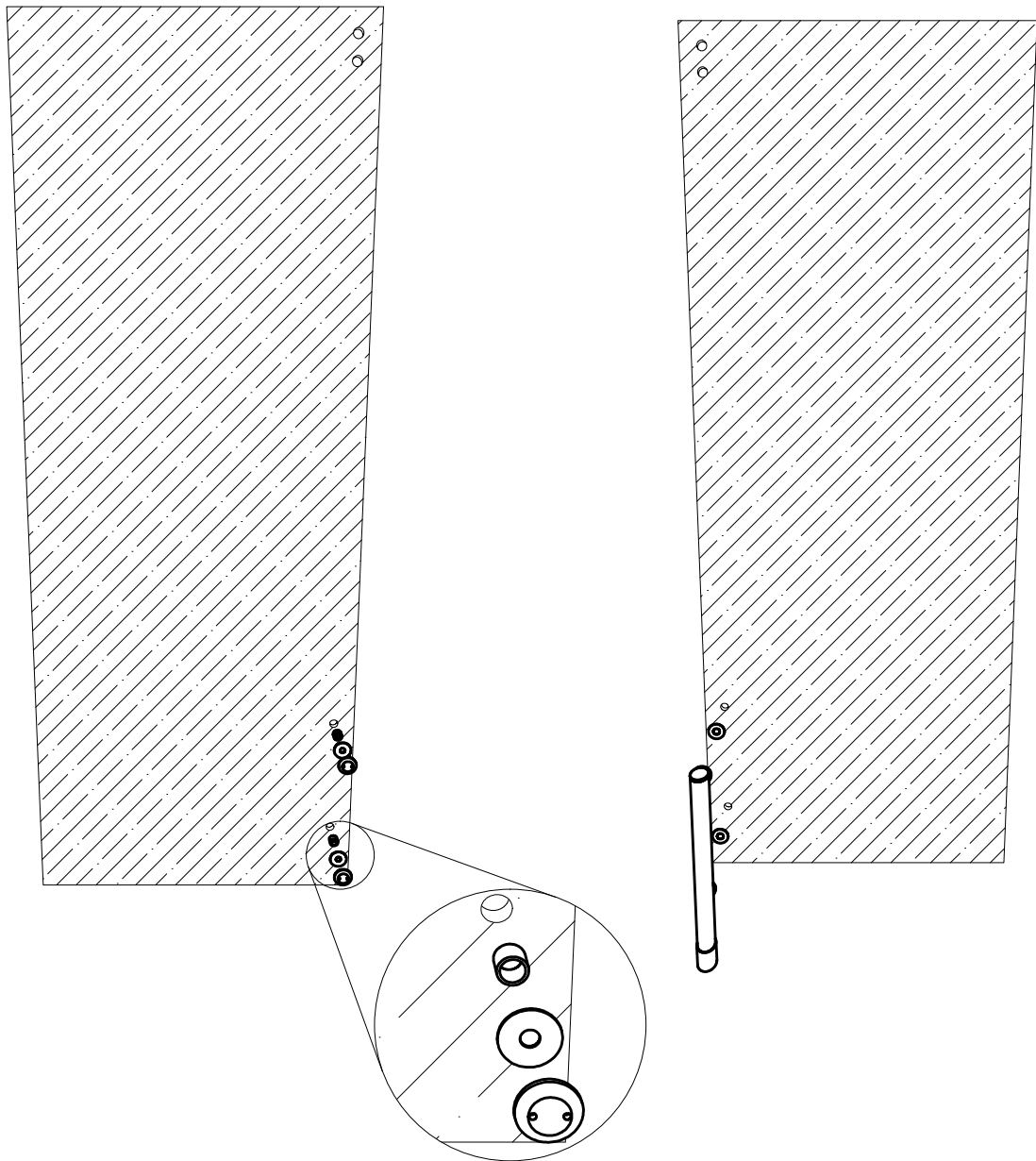

SC2.09

ZENITH SC2 - INSTALL THE DOOR CLOSER ON THE DOOR

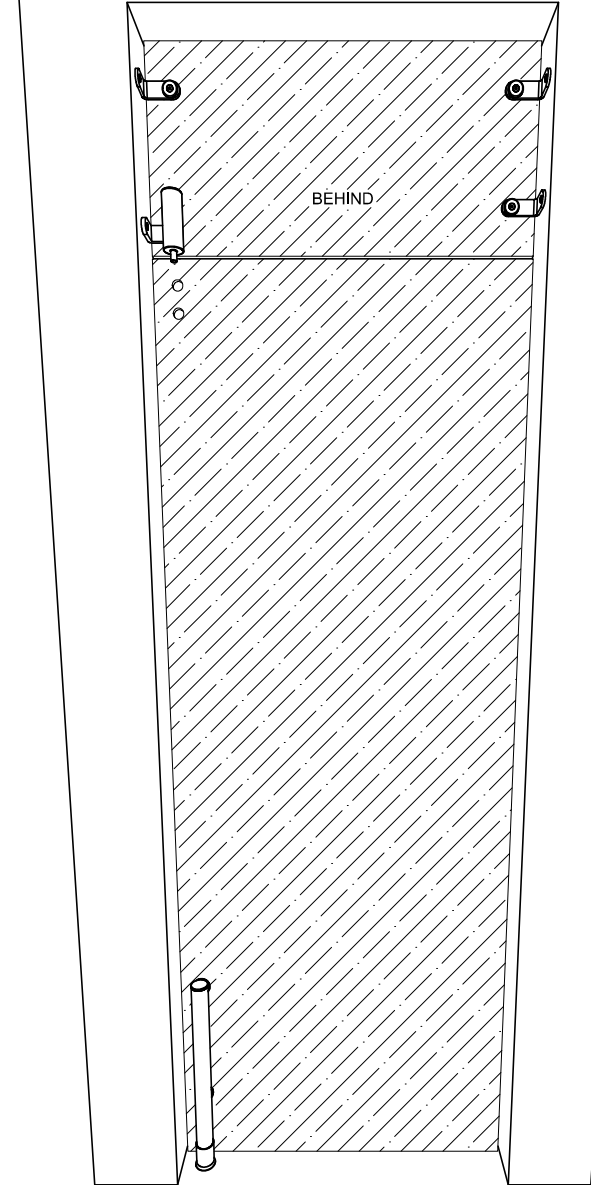
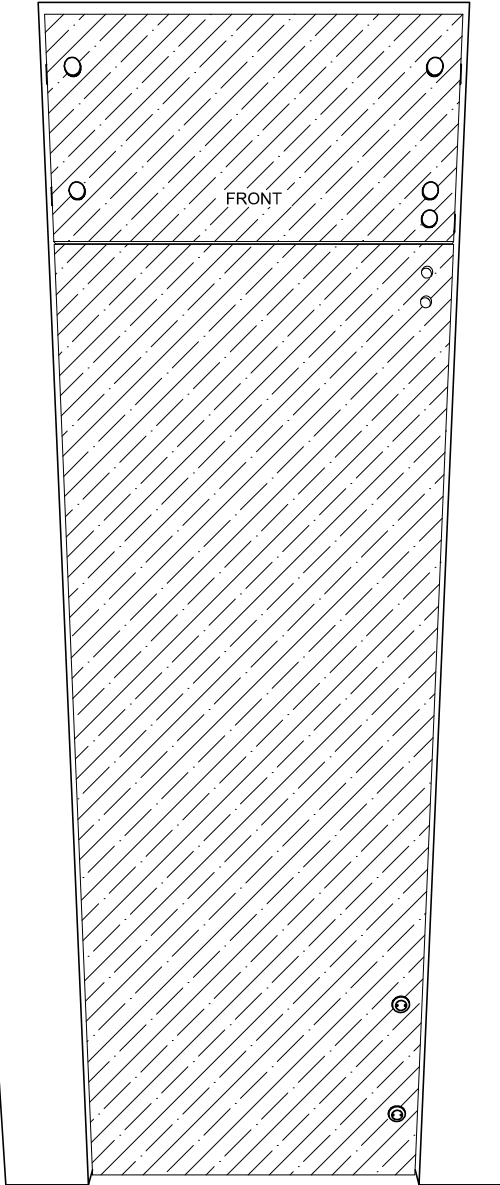

SC2.10

ZENITH SC2 - FIT THE GLASS DOOR AS INDICATED

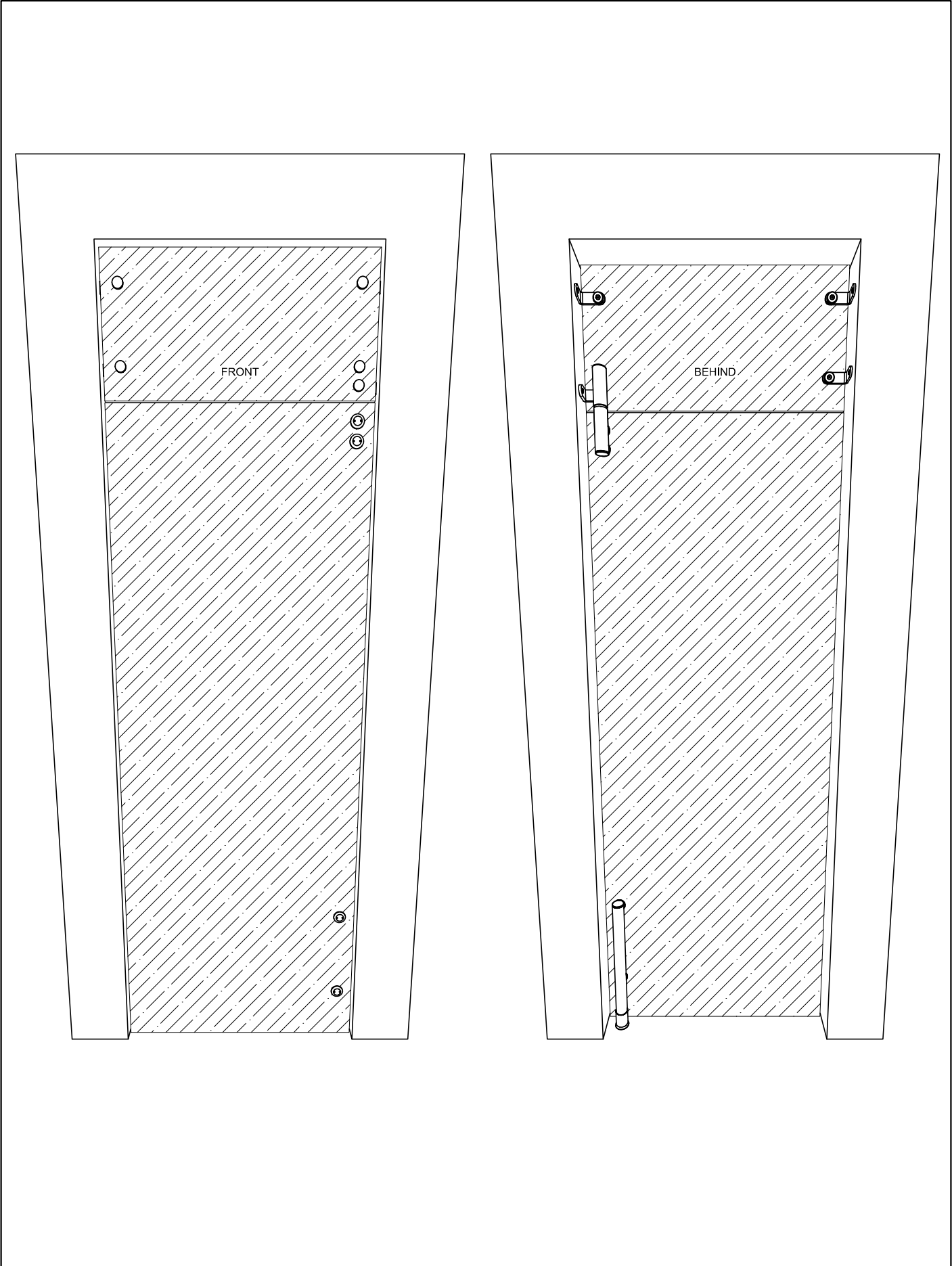

SC2.11

ZENITH SC2 - INSTALL THE REMAINING ACCESSORIES OF THE DOOR CLOSER AND THE WALL BRACKETS